

电机左折-L Motor Left Side

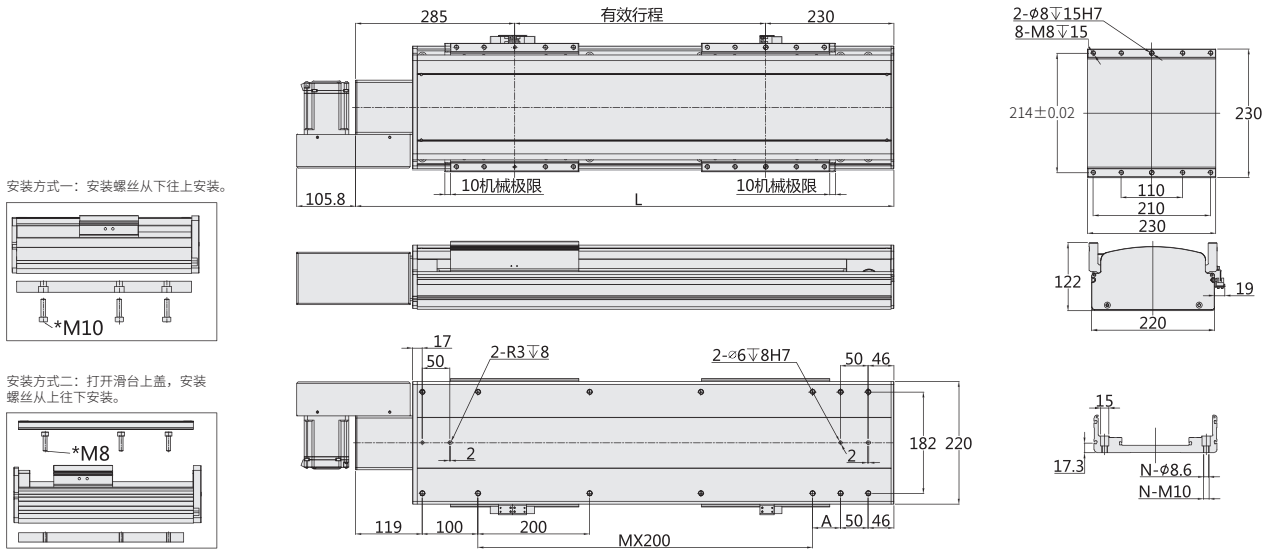

有效行程	300	350	400	450	500	550	600	650	700	750	800	850	900	950	1000	1050	1100	1150	1200	1250	1300	1350	1400	1450	1500	1550	1600	1650
L	815	865	915	965	1015	1065	1115	1165	1215	1265	1315	1365	1415	1465	1515	1565	1615	1665	1715	1765	1815	1865	1915	1965	2015	2065	2115	2165
A	100	150	200	50	100	150	200	50	100	150	200	50	100	150	200	50	100	150	200	50	100	150	200	50	100	150	200	50
M	2	2	2	3	3	3	3	4	4	4	4	5	5	5	5	6	6	6	6	7	7	7	7	8	8	8	8	9
N	12	12	12	14	14	14	14	16	16	16	16	18	18	18	18	20	20	20	20	22	22	22	22	24	24	24	24	26
KG	34.8	36	37.2	38.4	39.6	40.8	42	43.2	44.4	45.6	46.8	48	49.2	51.4	52.6	53.8	55	56.2	57.4	58.6	59.8	61	62.2	63.4	64.6	65.8	67	68.2
有效行程	1700	1750	1800	1850	1900	1950	2000	2100	2200	2300	2400	2500	2600	2700	2800	2900	3000	3100	3200	3300	3400	3500	3600	3700	3800	3900	4000	4100
L	2215	2265	2315	2365	2415	2465	2515	2615	2715	2815	2915	3015	3115	3215	3315	3415	3515	3615	3715	3815	3915	4015	4115	4215	4315	4415	4515	4615
A	100	150	200	50	100	150	200	100	200	100	200	100	200	100	200	100	200	100	200	100	200	100	200	100	200	100	200	100
M	9	9	9	10	10	10	10	11	11	12	12	13	13	14	14	15	15	16	16	17	17	18	18	19	19	20	20	21
N	26	26	26	28	28	28	28	30	30	32	32	34	34	36	36	38	38	40	40	42	42	44	44	46	46	48	48	50
KG	69.4	70.6	71.8	73.0	74.2	75.4	76.6	79.0	81.4	83.8	86.2	88.6	91.0	93.4	95.8	98.2	100.6	103.0	105.4	107.8	110.2	112.6	115.0	117.4	119.8	122.2	124.6	127.0

注: 以上不含电机重量。
Note: Not including motor weight.

电机右折-R Motor Right Side

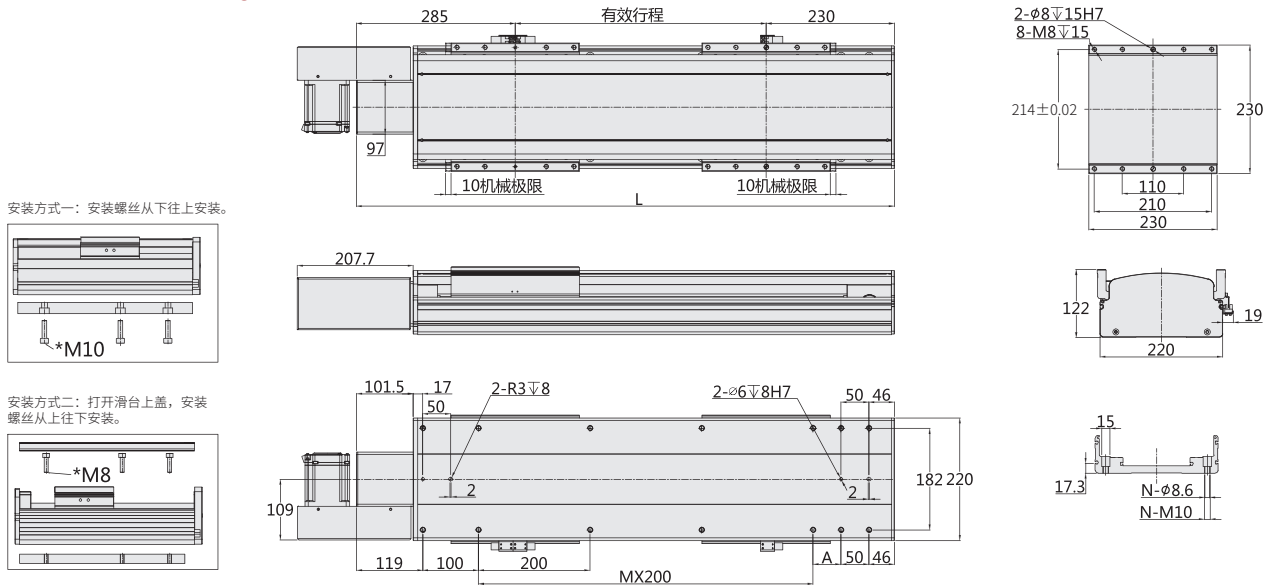

有效行程	300	350	400	450	500	550	600	650	700	750	800	850	900	950	1000	1050	1100	1150	1200	1250	1300	1350	1400	1450	1500	1550	1600	1650
L	815	865	915	965	1015	1065	1115	1165	1215	1265	1315	1365	1415	1465	1515	1565	1615	1665	1715	1765	1815	1865	1915	1965	2015	2065	2115	2165
A	100	150	200	50	100	150	200	50	100	150	200	50	100	150	200	50	100	150	200	50	100	150	200	50	100	150	200	50
M	2	2	2	3	3	3	3	4	4	4	4	5	5	5	5	6	6	6	6	7	7	7	7	8	8	8	8	9
N	12	12	12	14	14	14	14	16	16	16	16	18	18	18	18	20	20	20	20	22	22	22	22	24	24	24	24	26
KG	34.8	36	37.2	38.4	39.6	40.8	42	43.2	44.4	45.6	46.8	48	49.2	51.4	52.6	53.8	55	56.2	57.4	58.6	59.8	61	62.2	63.4	64.6	65.8	67	68.2
有效行程	1700	1750	1800	1850	1900	1950	2000	2100	2200	2300	2400	2500	2600	2700	2800	2900	3000	3100	3200	3300	3400	3500	3600	3700	3800	3900	4000	4100
L	2215	2265	2315	2365	2415	2465	2515	2615	2715	2815	2915	3015	3115	3215	3315	3415	3515	3615	3715	3815	3915	4015	4115	4215	4315	4415	4515	4615
A	100	150	200	50	100	150	200	100	200	100	200	100	200	100	200	100	200	100	200	100	200	100	200	100	200	100	200	100
M	9	9	9	10	10	10	10	11	11	12	12	13	13	14	14	15	15	16	16	17	17	18	18	19	19	20	20	21
N	26	26	26	28	28	28	28	30	30	32	32	34	34	36	36	38	38	40	40	42	42	44	44	46	46	48	48	50
KG	69.4	70.6	71.8	73.0	74.2	75.4	76.6	79.0	81.4	83.8	86.2	88.6	91.0	93.4	95.8	98.2	100.6	103.0	105.4	107.8	110.2	112.6	115.0	117.4	119.8	122.2	124.6	127.0

注: 以上不含电机重量。
Note: Not including motor weight.



电机左上折-LU Motor Folds on the Upper Left

安装方式一：安装螺丝从下往上安装。

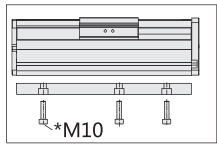

安装方式二：打开滑台上盖，安装螺丝从上往下安装。

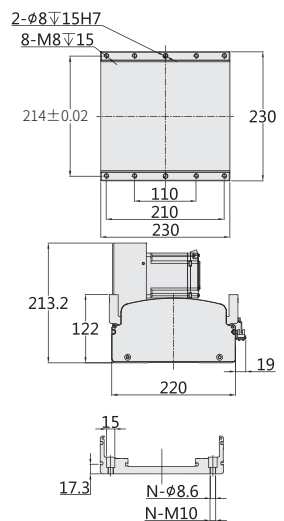
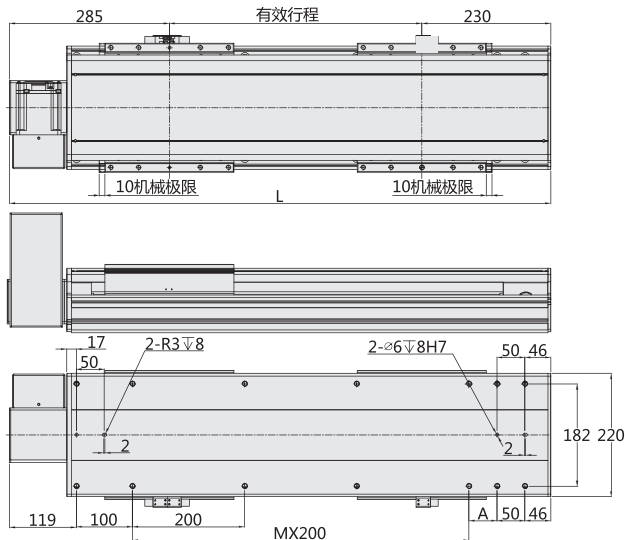
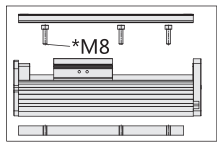

有效行程	300	350	400	450	500	550	600	650	700	750	800	850	900	950	1000	1050	1100	1150	1200	1250	1300	1350	1400	1450	1500	1550	1600	1650
L	815	865	915	965	1015	1065	1115	1165	1215	1265	1315	1365	1415	1465	1515	1565	1615	1665	1715	1765	1815	1865	1915	1965	2015	2065	2115	2165
A	100	150	200	50	100	150	200	50	100	150	200	50	100	150	200	50	100	150	200	50	100	150	200	50	100	150	200	50
M	2	2	2	3	3	3	3	4	4	4	4	5	5	5	5	6	6	6	6	7	7	7	7	8	8	8	8	9
N	12	12	12	14	14	14	14	16	16	16	16	18	18	18	18	20	20	20	20	22	22	22	22	24	24	24	24	26
KG	34.8	36	37.2	38.4	39.6	40.8	42	43.2	44.4	45.6	46.8	48	49.2	51.4	52.6	53.8	55	56.2	57.4	58.6	59.8	61	62.2	63.4	64.6	65.8	67	68.2
有效行程	1700	1750	1800	1850	1900	1950	2000	2100	2200	2300	2400	2500	2600	2700	2800	2900	3000	3100	3200	3300	3400	3500	3600	3700	3800	3900	4000	4100
L	2215	2265	2315	2365	2415	2465	2515	2615	2715	2815	2915	3015	3115	3215	3315	3415	3515	3615	3715	3815	3915	4015	4115	4215	4315	4415	4515	4615
A	100	150	200	50	100	150	200	100	200	100	200	100	200	100	200	100	200	100	200	100	200	100	200	100	200	100	200	100
M	9	9	9	10	10	10	10	11	11	12	12	13	13	14	14	15	15	16	16	17	17	18	18	19	19	20	20	21
N	26	26	26	28	28	28	28	30	30	32	32	34	34	36	36	38	38	40	40	42	42	44	44	46	46	48	48	50
KG	69.4	70.6	71.8	73.0	74.2	75.4	76.6	79.0	81.4	83.8	86.2	88.6	91.0	93.4	95.8	98.2	100.6	103.0	105.4	107.8	110.2	112.6	115.0	117.4	119.8	122.2	124.6	127.0

注：以上不含电机重量。
Note: Not including motor weight.

电机左下折-LD Motor Folds Down Deflt

安装方式一：安装螺丝从下往上安装。

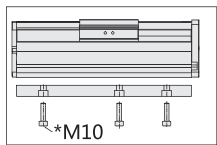

安装方式二：打开滑台上盖，安装螺丝从上往下安装。

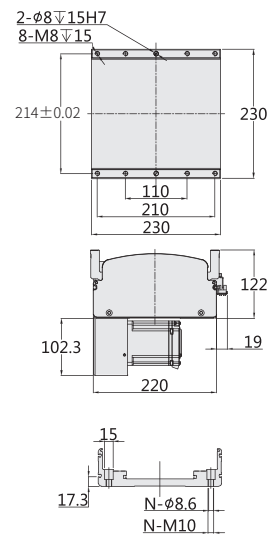
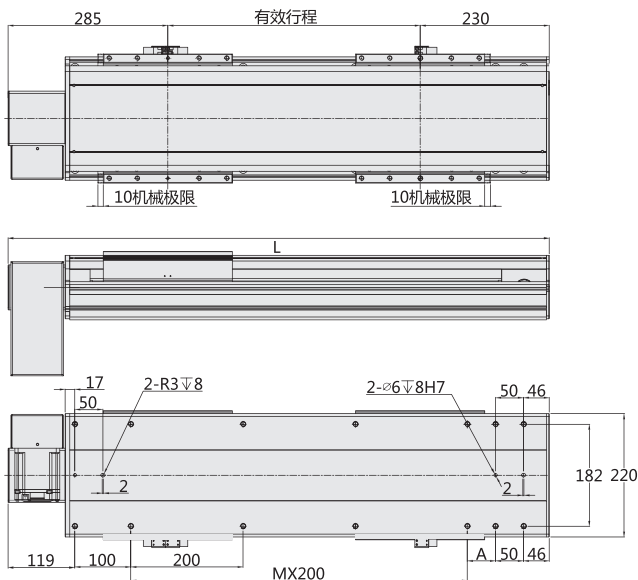
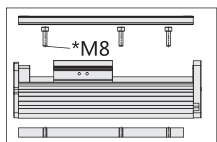

有效行程	300	350	400	450	500	550	600	650	700	750	800	850	900	950	1000	1050	1100	1150	1200	1250	1300	1350	1400	1450	1500	1550	1600	1650
L	815	865	915	965	1015	1065	1115	1165	1215	1265	1315	1365	1415	1465	1515	1565	1615	1665	1715	1765	1815	1865	1915	1965	2015	2065	2115	2165
A	100	150	200	50	100	150	200	50	100	150	200	50	100	150	200	50	100	150	200	50	100	150	200	50	100	150	200	50
M	2	2	2	3	3	3	3	4	4	4	4	5	5	5	5	6	6	6	6	7	7	7	7	8	8	8	8	9
N	12	12	12	14	14	14	14	16	16	16	16	18	18	18	18	20	20	20	20	22	22	22	22	24	24	24	24	26
KG	34.8	36	37.2	38.4	39.6	40.8	42	43.2	44.4	45.6	46.8	48	49.2	51.4	52.6	53.8	55	56.2	57.4	58.6	59.8	61	62.2	63.4	64.6	65.8	67	68.2
有效行程	1700	1750	1800	1850	1900	1950	2000	2100	2200	2300	2400	2500	2600	2700	2800	2900	3000	3100	3200	3300	3400	3500	3600	3700	3800	3900	4000	4100
L	2215	2265	2315	2365	2415	2465	2515	2615	2715	2815	2915	3015	3115	3215	3315	3415	3515	3615	3715	3815	3915	4015	4115	4215	4315	4415	4515	4615
A	100	150	200	50	100	150	200	100	200	100	200	100	200	100	200	100	200	100	200	100	200	100	200	100	200	100	200	100
M	9	9	9	10	10	10	10	11	11	12	12	13	13	14	14	15	15	16	16	17	17	18	18	19	19	20	20	21
N	26	26	26	28	28	28	28	30	30	32	32	34	34	36	36	38	38	40	40	42	42	44	44	46	46	48	48	50
KG	69.4	70.6	71.8	73.0	74.2	75.4	76.6	79.0	81.4	83.8	86.2	88.6	91.0	93.4	95.8	98.2	100.6	103.0	105.4	107.8	110.2	112.6	115.0	117.4	119.8	122.2	124.6	127.0

注：以上不含电机重量。
Note: Not including motor weight.

电机右上折-RU Motor Folds up on the Right

安装方式一：安装螺丝从下往上安装。

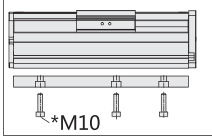

安装方式二：打开滑台上盖，安装螺丝从上往下安装。

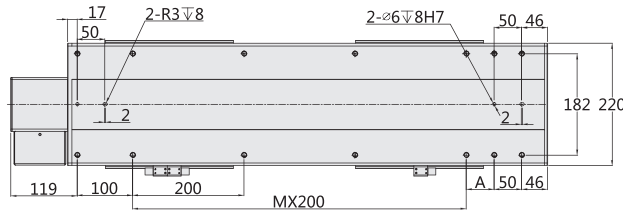
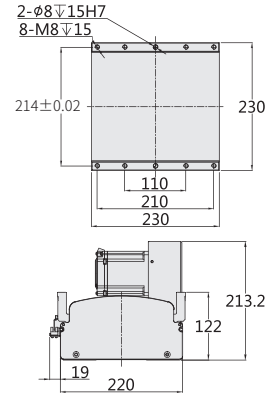
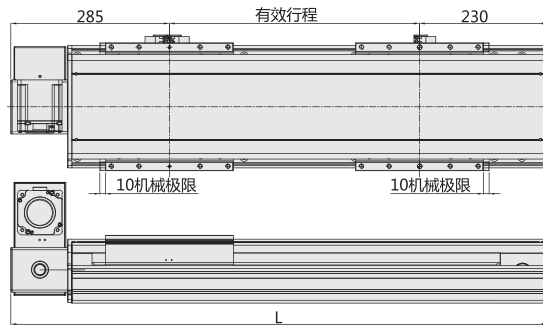
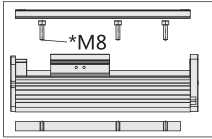

有效行程	300	350	400	450	500	550	600	650	700	750	800	850	900	950	1000	1050	1100	1150	1200	1250	1300	1350	1400	1450	1500	1550	1600	1650
L	815	865	915	965	1015	1065	1115	1165	1215	1265	1315	1365	1415	1465	1515	1565	1615	1665	1715	1765	1815	1865	1915	1965	2015	2065	2115	2165
A	100	150	200	50	100	150	200	50	100	150	200	50	100	150	200	50	100	150	200	50	100	150	200	50	100	150	200	50
M	2	2	2	3	3	3	3	4	4	4	4	5	5	5	5	6	6	6	6	7	7	7	7	8	8	8	8	9
N	12	12	12	14	14	14	14	16	16	16	16	18	18	18	18	20	20	20	20	22	22	22	22	24	24	24	24	26
KG	34.8	36	37.2	38.4	39.6	40.8	42	43.2	44.4	45.6	46.8	48	49.2	51.4	52.6	53.8	55	56.2	57.4	58.6	59.8	61	62.2	63.4	64.6	65.8	67	68.2
有效行程	1700	1750	1800	1850	1900	1950	2000	2100	2200	2300	2400	2500	2600	2700	2800	2900	3000	3100	3200	3300	3400	3500	3600	3700	3800	3900	4000	4100
L	2215	2265	2315	2365	2415	2465	2515	2615	2715	2815	2915	3015	3115	3215	3315	3415	3515	3615	3715	3815	3915	4015	4115	4215	4315	4415	4515	4615
A	100	150	200	50	100	150	200	100	200	100	200	100	200	100	200	100	200	100	200	100	200	100	200	100	200	100	200	100
M	9	9	9	10	10	10	10	11	11	12	12	13	13	14	14	15	15	16	16	17	17	18	18	19	19	20	20	21
N	26	26	26	28	28	28	28	30	30	32	32	34	34	36	36	38	38	40	40	42	42	44	44	46	46	48	48	50
KG	69.4	70.6	71.8	73.0	74.2	75.4	76.6	79.0	81.4	83.8	86.2	88.6	91.0	93.4	95.8	98.2	100.6	103.0	105.4	107.8	110.2	112.6	115.0	117.4	119.8	122.2	124.6	127.0

注：以上不含电机重量。
Note: Not including motor weight.

电机右下折-RD Motor Folds Down on the Right

安装方式一：安装螺丝从下往上安装。

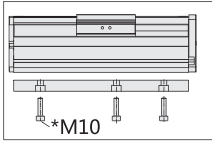

安装方式二：打开滑台上盖，安装螺丝从上往下安装。

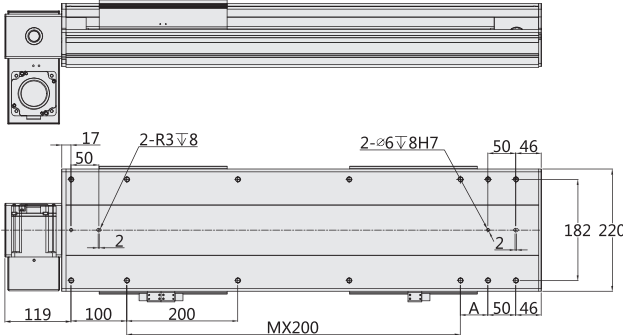
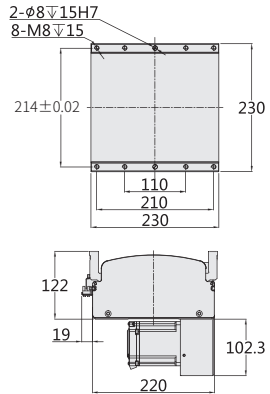
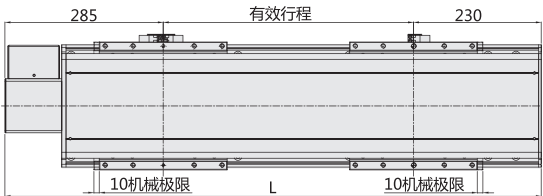
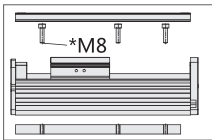

有效行程	300	350	400	450	500	550	600	650	700	750	800	850	900	950	1000	1050	1100	1150	1200	1250	1300	1350	1400	1450	1500	1550	1600	1650
L	815	865	915	965	1015	1065	1115	1165	1215	1265	1315	1365	1415	1465	1515	1565	1615	1665	1715	1765	1815	1865	1915	1965	2015	2065	2115	2165
A	100	150	200	50	100	150	200	50	100	150	200	50	100	150	200	50	100	150	200	50	100	150	200	50	100	150	200	50
M	2	2	2	3	3	3	3	4	4	4	4	5	5	5	5	6	6	6	6	7	7	7	7	8	8	8	8	9
N	12	12	12	14	14	14	14	16	16	16	16	18	18	18	18	20	20	20	20	22	22	22	22	24	24	24	24	26
KG	34.8	36	37.2	38.4	39.6	40.8	42	43.2	44.4	45.6	46.8	48	49.2	51.4	52.6	53.8	55	56.2	57.4	58.6	59.8	61	62.2	63.4	64.6	65.8	67	68.2
有效行程	1700	1750	1800	1850	1900	1950	2000	2100	2200	2300	2400	2500	2600	2700	2800	2900	3000	3100	3200	3300	3400	3500	3600	3700	3800	3900	4000	4100
L	2215	2265	2315	2365	2415	2465	2515	2615	2715	2815	2915	3015	3115	3215	3315	3415	3515	3615	3715	3815	3915	4015	4115	4215	4315	4415	4515	4615
A	100	150	200	50	100	150	200	100	200	100	200	100	200	100	200	100	200	100	200	100	200	100	200	100	200	100	200	100
M	9	9	9	10	10	10	10	11	11	12	12	13	13	14	14	15	15	16	16	17	17	18	18	19	19	20	20	21
N	26	26	26	28	28	28	28	30	30	32	32	34	34	36	36	38	38	40	40	42	42	44	44	46	46	48	48	50
KG	69.4	70.6	71.8	73.0	74.2	75.4	76.6	79.0	81.4	83.8	86.2	88.6	91.0	93.4	95.8	98.2	100.6	103.0	105.4	107.8	110.2	112.6	115.0	117.4	119.8	122.2	124.6	127.0

注：以上不含电机重量。
Note: Not including motor weight.